



**MACHINE
OF THE YEAR 2019**



KEILER II

ROPA



MACHINE
OF THE YEAR 2019



- 4 Fully hydraulic drive design
- 6 Pickup
- 8 Quick-change system
- 10 Cleaning 4 pintle belts
- 14 Overloading bunker (Keiler 2 L)
- 18 Bunker 7.5 t and tray filler
- 19 Keiler 2 Silver Edition
- 20 ROPA potato scale
- 22 Sorting platform
- 24 Cleaning 2 pintle belts (Keiler 2 Classic)
- 27 Overloading bunker (Keiler 2 Classic)
- 28 XL bunker (Keiler 2 Classic)
- 29 Double bunker (Keiler 2 Classic)
- 30 Cabin and terminal
- 32 ISOBUS operating concept
- 34 ISOBUS assistance systems
- 36 Operation on sorting platform
- 38 Chassis, telescopic axle, lane lifting
- 40 Drive wheel (Keiler 2 WD)
- 42 Maintenance & service
- 44 Potato squeezer
- 46 Optional equipment
- 48 Impressions from around the world
- 50 Technical data



Fully hydraulic drive

The fully hydraulic drive allows the speed of all cleaning units to be controlled automatically. Thanks to the load-sensing hydraulics all cleaning units are supplied with the maximum oil volume from a PTO speed of 650 rpm. In order to adapt to different harvesting conditions the cleaning elements can be controlled individually regardless of the tractor engine speed from minimum to maximum speed - no need to press the accelerator pedal. If the full oil amount is not required, the PTO as well as the engine speed can be reduced



further. The resulting fuel consumption efficiency is a major advantage compared to traditional drive concepts. Individually configurable lifting programs that can be saved simplify manual or automatic adjustment for different harvesting conditions for the driver.

Unique drive concept

- The speed of the sieve conveyors can be adjusted independently of the speed of the leaf chain
- All cleaning units maintain their optimal speed independently of the PTO speed
- The speed of the leaf chain can be reduced to 10% of the sieve conveyor speed
- A continuous pressure monitor prevents overrunning the lifter
- No mechanical slip clutch necessary – significantly improved power transmission and no wear
- Soft start of all belts and cleaning units
- No chains, belts and tensioners – no adjustment, fewer wear parts, increased operational reliability
- Two articulated shafts, therefore fewer lubrication points
- Significantly reduced noise level, more comfortable working with the machine
- Save fuel with reduced engine speed
- Many settings can be made directly on the terminal at the sorting platform
- Fast and convenient adjustment of the machine for variable harvesting conditions
- Fully hydraulic drive of the complete harvester, thus extremely low vibration and reduced noise

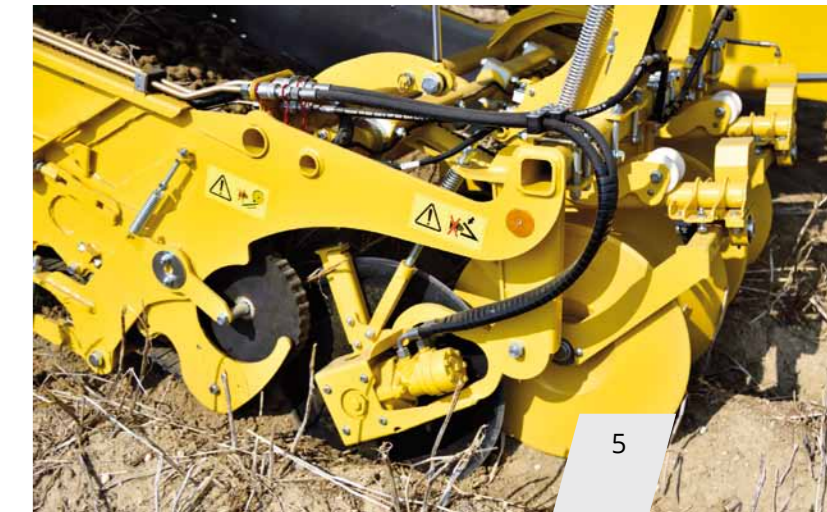
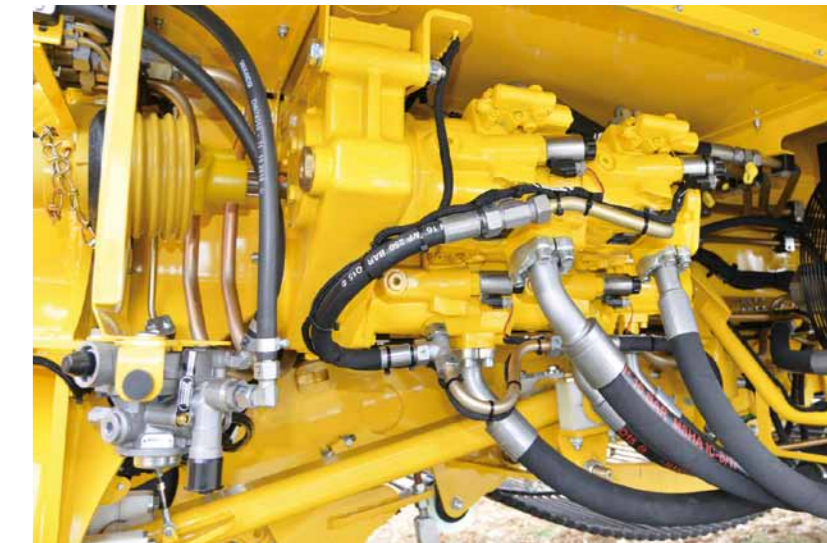

Pickup control - fully automatic ROPA ridge pressure regulation

- Standard ridge pressure relief and ridge pressure control combined with hydraulic lifting depth adjustment
- Adjustment while driving - conveniently from the tractor cabin
- Depth guide and ridge pressure relief adjustable for every row
- Single row pickup available – particularly useful for lifting through lanes
- Optional range of different lifter shares (one-blade, two-blade, three-blade, centre-blade)
- Optional range of different ridge rollers (flat, deep, half, plastic)

Additional disc coulters (optional)

The additional disc coulters cut through even large amounts of haulm for harvesting without blockages

Hydraulically driven disc coulters right/middle/left (optional)

The hydraulically driven disc coulters guarantee clean and efficient harvesting without blockages. The speed is controlled manually or automatically depending on the driving speed - optionally synchronously or leading.



Standard ROPA quick-change system - High efficiency with short setup times

ROPA has designed a practical new quick-change system for switching between ridge pickup and swath pickup. The Keiler 2 can be switched from potato harvesting to onion harvesting in just a few minutes. The reverse is the same. One person can perform the complete coupling process easily and without requiring special tools. A practical solution for potato farmers who also grow onions and red beets who may need to change their pickup system several times a day.

- Faster and easier change of pickup
- The driver can do the change alone without requiring assistance from other persons
- Specialized tools or forklift not required
- Conversion can be done in the field
- Attachment of the pickup offers the best accessibility for fast and easy change of sieve conveyors – switch to different pitch
- Cover belt and sieve conveyor can run synchronously

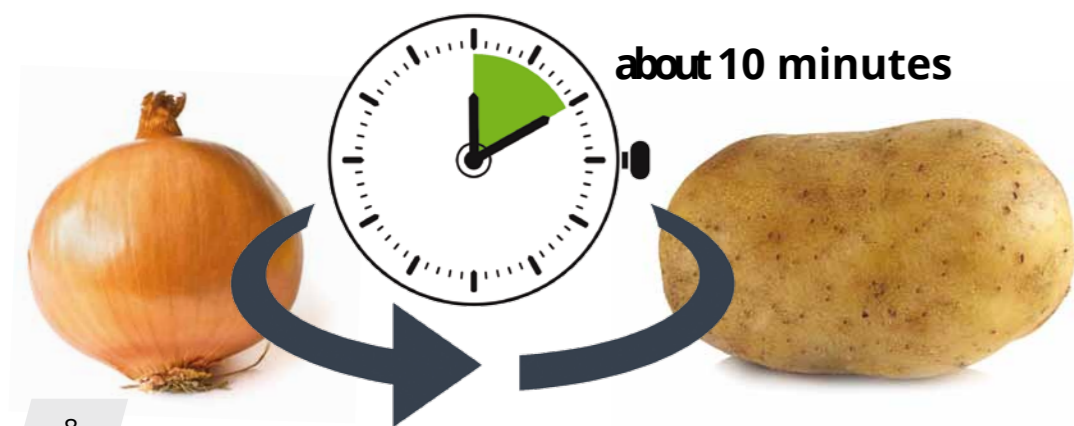

Generously measured cleaning elements, perfectly matched

- Large sieve conveyors with variably adjustable shaker (V2A in sieving channel as standard)
- Two transfer stages for removal of large amounts of foreign matter
- Integrated sieve conveyor tensioner with optional cleaning roller
- Clod breaker for sieve conveyor 1 and 2 (optional)
- Rotating finger comb (UFK) steplessly adjustable in height and speed on both sides
- Adjustment of the infeed width to the UFK by moving the deflector rollers allows variable cleaning settings
- Speed ratio of leaf chain to sieve conveyor 2 can be adjusted
- Excellent haulm ejection with 7 rows of haulm retainer springs, steplessly adjustable
- Pre-separation with hydraulically driven triple deflector roller or twin deflector roller
- Gentle and efficient cleaning even at high throughput
- All cleaning devices maintain their set speed independently of PTO speed



Longer cleaning distance for gentle and efficient separation

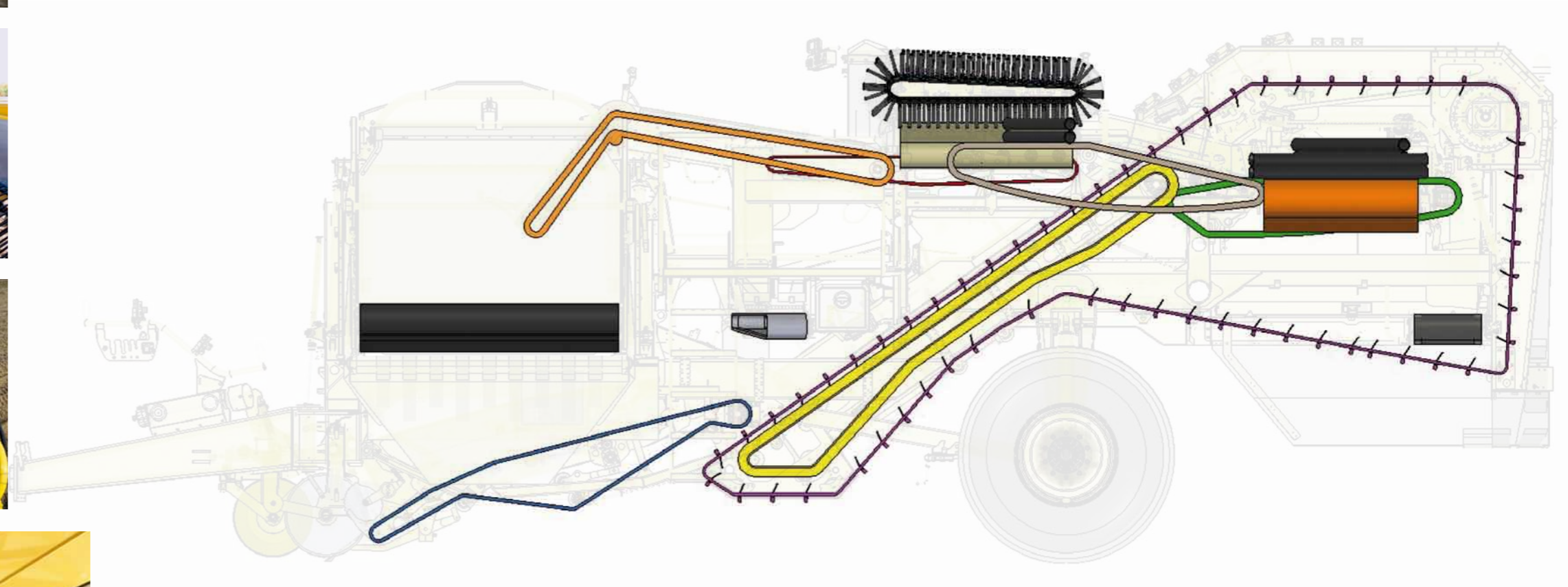

The ROPA Keiler has large cleaning components with maximum cleaning area for gentle and efficient cleaning. The ROPA Keiler is particularly efficient for harvesting on heavy soils and/or during bad weather.

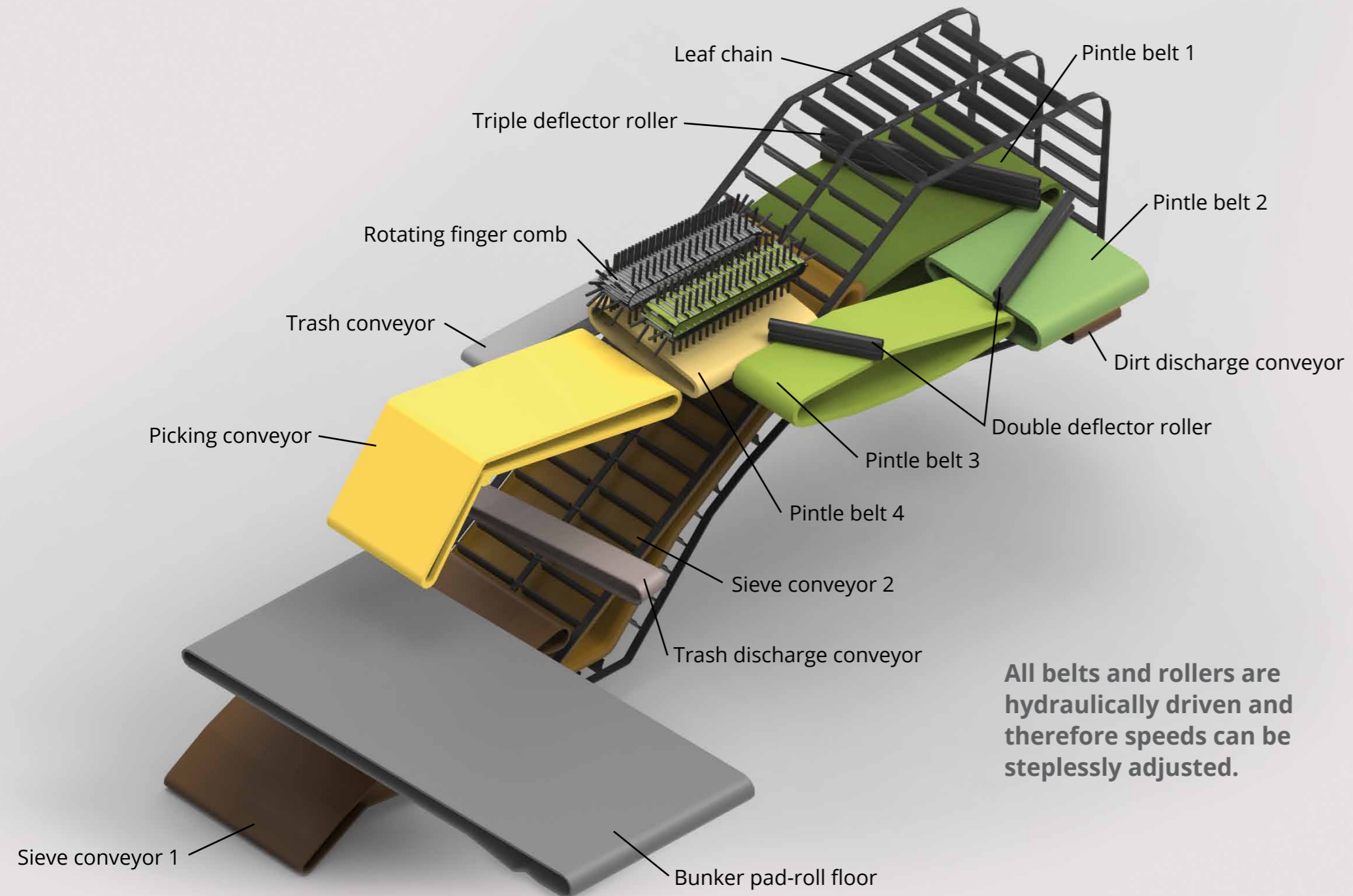

All belts and rollers are hydraulically driven and therefore speeds can be steplessly adjusted.



Keiler 2 L 4 pintle belts without trash conveyor and without sorting platform on the right



Keiler 2 4 pintle belts with deflector rollers





KEILER II L



ROPA Keiler 2 L with overloading bunker - non-stop harvesting

- Optimal filling of the bunker with ultrasound sensors
- Bunker capacity approx. 5.5 t
- Immersion depth 600 mm at 3.5 m board wall height
- Transfer roller with 185 mm diameter made of PU discs for gentle transfer to the unloading conveyor, additional cleaning of loose soil
- Constructive separation of bunker trough and unloading conveyor for time-saving and complete bunker emptying
- Direct drive of the rod conveyor - trouble-free unloading under all conditions
- The sequential discharge of the bunker trough contents onto the unloading conveyor in combination with the extendable axle increases driving stability in the field and makes it easier for the driver
- 3-way foldable unloading conveyor enables flexible unloading



**MACHINE
OF THE YEAR 2019**



Protection of tubers

Adjustments that can be individually and easily changed ensure high throughput with increased cleaning performance. The speed ratio of the leaf chain to the sieve conveyor can be adjusted steplessly and conveniently from the driver's seat. The electrically height-adjustable rotating finger comb (UFK) and numerous additional adjustment options form the basis for efficient and gentle cleaning of potatoes.

Truck loading

The Keiler 2 has a continuously adjustable unloading conveyor speed as standard. A hydraulically operated front bunker articulation part and a tray filler with rubber baffle for maximum protection of the tubers are available optionally.



Keiler 2 Silver Edition

with V2A stainless steel bunker walls



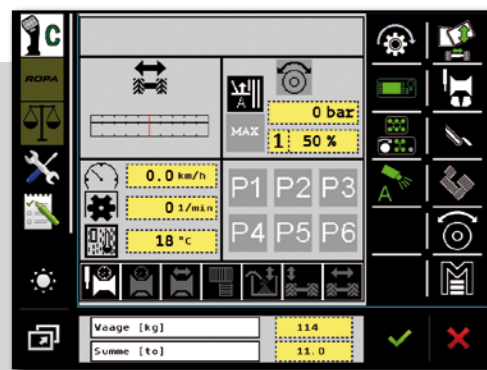

Live view of the weighing data below the usual terminal operation

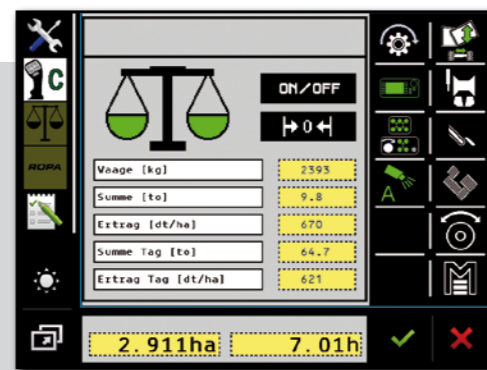

Potato scale terminal mask with measurement data overview and setting options

Potato scale - weighing before loading

The new ROPA weighing system makes it possible to determine almost exactly the bunker contents before its unloading. This system allows the transport vehicles to be loaded traffic-safely and an initial yield assessment to be made.

The bunker contents are determined via 3 measuring pins at the front and rear of the bunker. The static weighing is always carried out when the bunker is raised. Measuring on slopes can also be carried out without any problems thanks to the interaction between the bunker scale software and the slope inclination sensor.

In order to ensure that the weighing system always works at 100 %, every operator can quickly and easily perform zeroing (tare function).

The determined bunker content data are automatically stored and transferred to the season, order and daily counter.





Ergonomic working on the sorting platform

- Height-adjustable platforms offer greater safety and comfort for sorters, even over long working days
- Free positioning of platforms
- Maximum freedom of movement
- Generously sized chutes
- Rounded edges and covers for user safety



Folding ladder damping for safe access



Clamping protection

Working platform, 300 mm extendable - immense working area allows freedom of movement





Sorting platform can be swung out for even more space



ROPA Keiler 2 Classic with 2 pintle belts

Many proven components of the Keiler 2 have been adopted in the design of Keiler 2 Classic. The Keiler 2 Classic differs from the Keiler 2 mainly due to both pintle belts which function as separation devices. The overall design demonstrates very high output with maximum product protection in areas with low cleaning requirements (sandy or light soils). The Keiler 2 Classic with the pintle belt 1 and pintle belt 2 cleaning systems is easy to monitor, it is accessible and easy to service.

The very spacious sorting stand has ample space for up to 8 persons at the gently rising and generously dimensioned picking conveyor with an optional trash track. Thanks to the extendable platform, there is also space for additional sorters next to the trash track. Paired with the height-adjustable platforms this allows every workstation to be separately adjusted for maximum ease of working.

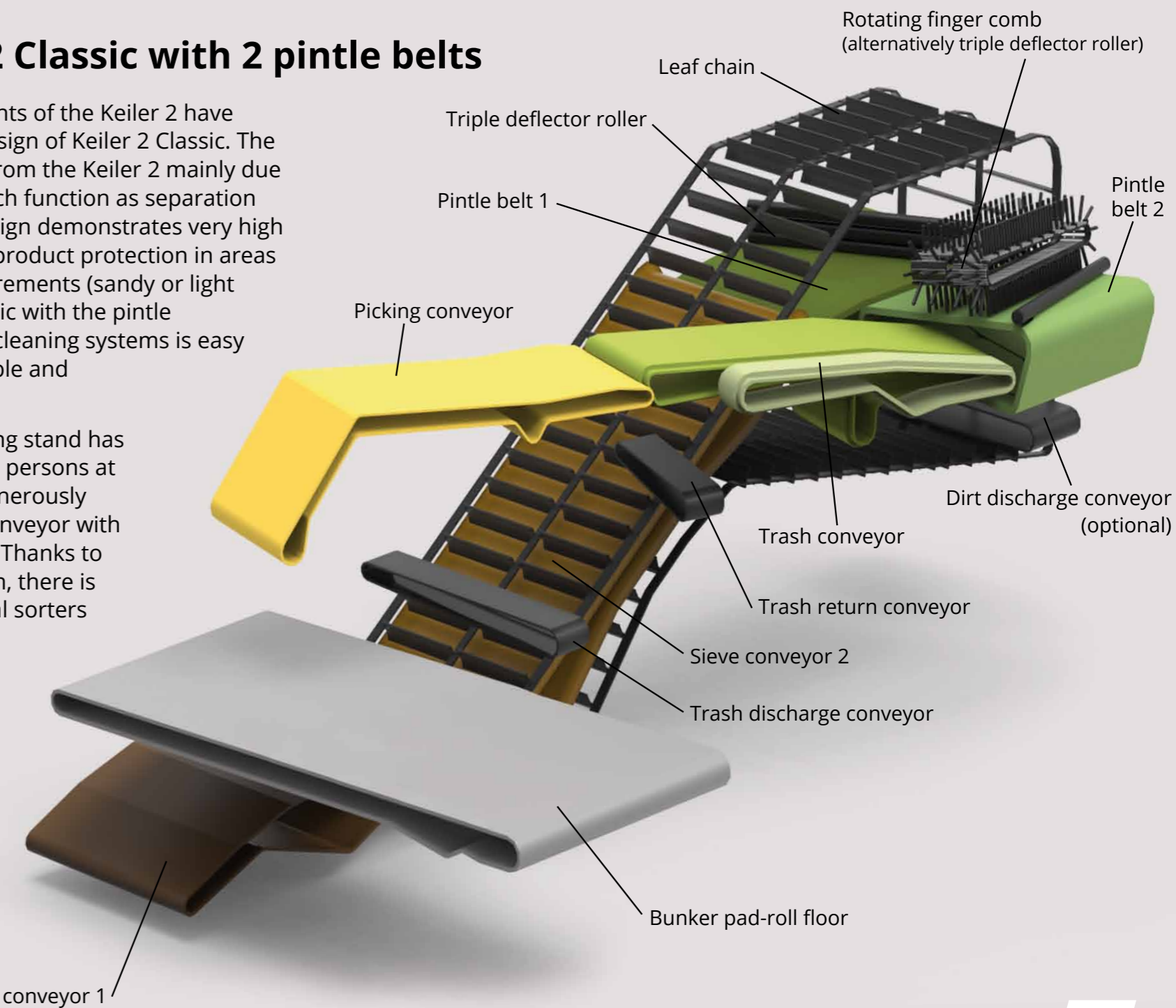



Keiler 2 Classic with triple deflector rollers



Keiler 2 Classic with UFK, trash track and grader rollers

Keiler 2 Classic with XL bunker as standard

The potato harvester Keiler 2 Classic with 2 separation units and a large sorting platform is particularly effective on light soils. With the new ROPA XL bunker, the bunker volume has been increased in order to make the best possible use of the high harvesting performance. The automatic filling system with ultrasound sensors ensures optimum filling of the bunker. The bunker can be supplied by an articulation unit, so the fall height of the trailer can be reduced for gentle trailer filling.

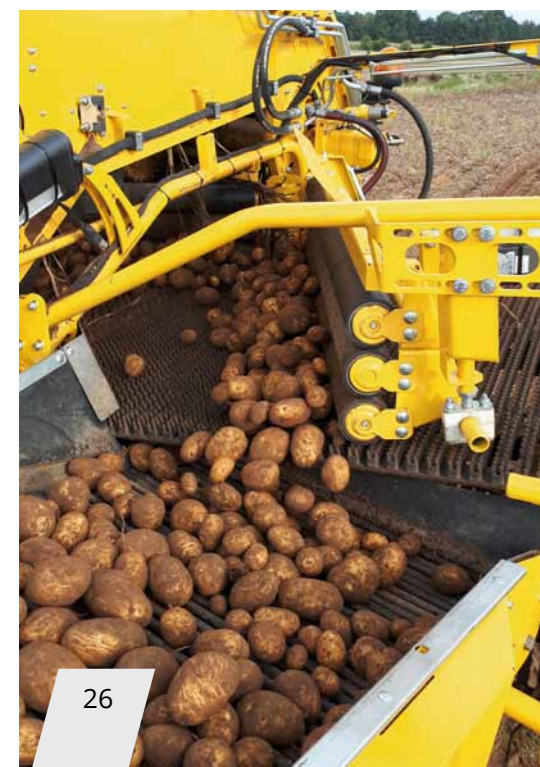

Individual cleaning

Where cleaning requirements are minimal, the rotating finger comb (UFK) can be replaced with triple deflector rollers and the trash track can be left out. This not only saves weight and costs, but also increases throughput. These options are available as modules for retrofit if required. The option of conversion is taken into account from the start of the design process.

The same applies for the machine with four pintle belts. This machine can be optionally designed without trash and discharge conveyor and fitted with deflector rollers instead of the UFK.



Keiler 2 Classic with overloading bunker

The Keiler 2 Classic can also be optionally fitted with drive wheel and overloading bunker. The volume of the overloading bunker on the Keiler 2 Classic can be increased to 6 t.

The quick-change frame for the pickup is also integrated as standard equipment, enabling this machine to be used for high-performance, gentle harvesting of onions and other special crops thanks to the reduced cleaning units.



Keiler 2 Classic with double bunker

Keiler 2 Classic with double bunker ensures gentle separation and allows small potatoes to be sorted out directly on the potato harvester.

Small-sized potatoes are sorted out by the grader rollers on the picking conveyor into the divided bunker segment, loaded separately on trailers or in boxes and can be sold during harvest time, e.g. as baby potatoes. It saves storage capacity and at the same time offers advantages in terms of ventilation and storability of normal crop.

Four grader rollers, steplessly adjustable in the range of 25 - 40 mm, perform separation directly after the picking conveyor. The bunker, divided in a ratio of 3 to 1, has separate filling slides and an automatic filling function for the main bunker. Both bunkers can be emptied separately from each other. The overloading height of 4.20 metres also enables efficient filling.



Removable picking table elevation





Large and user-friendly terminal – intuitive operation

- Clear and simple display with large function keys
- Up to 6 different lifter settings can be easily saved
- Simple and very fast adjustment to changing soil and crop conditions at the push of a button
- Display and adjustment of functions also available at the picking table terminal
- Intuitive operation of the entire harvester

Greater ease of use means greater harvesting quality and performance





Description of terminal and functions in the operation manual.
www.ropa-maschinenbau.de



Control element conforms to ISOBUS AUX-N standard, can be assigned as desired

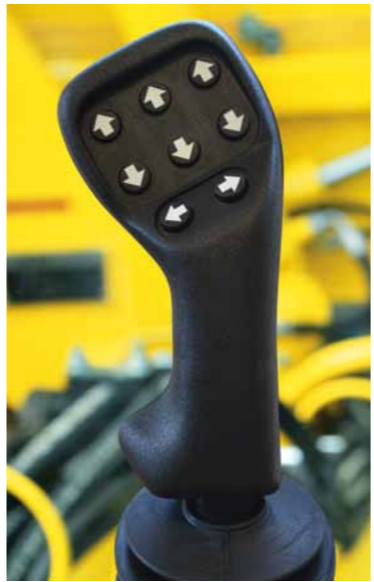

ISO control joystick

Intuitive operating concept

- ROPA Terminal is ergonomically and easily integrated into any tractor cabin
- ISOBUS 8-inch colour terminal with glass touch screen
- Self-explanatory icon display on screen
- Freely configurable user interface
- Ergonomically designed control elements with mini joysticks – orderly and easily understandable layout
- Individually configurable lifting programs that can be saved simplify manual or automatic adjustment for different harvesting conditions for the driver

Fully ISOBUS-compatible

- Operation with any ISOBUS terminal
- ISOBUS installation of modern tractors fully supported
- ISOBUS retrofit set for tractors without ISOBUS functions (optional)
- ISOBUS-AUX control elements left and right can be programmed individually (optional)
- Own terminal masks for the assignment visualisation
- ROPA 12-inch touch terminal (optional)

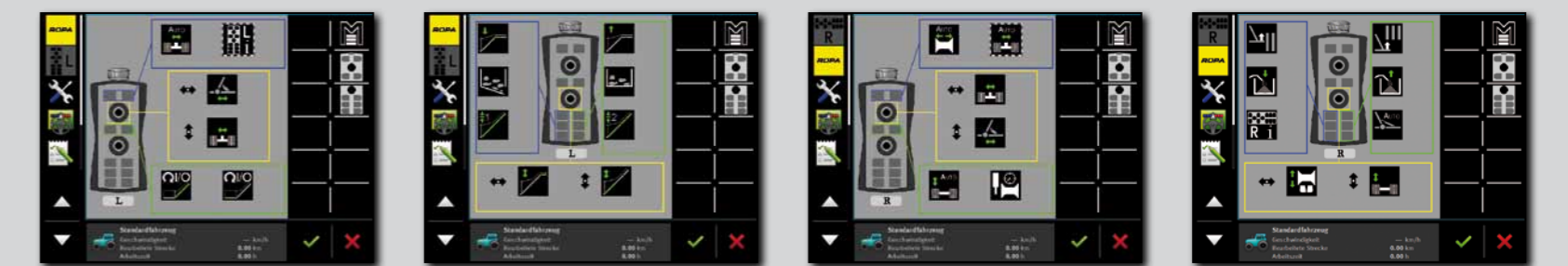

Control element left overloading bunker default assignment 1

Control element left overloading bunker default assignment 2

Control element right default assignment 1

Control element right default assignment 2

Harvesting programs can be saved

- Six programming buttons for fast saving and calling up various machine settings
- Individually configurable and can be saved with names
- Ideal for repeating harvesting conditions

Sieve conveyor and pintle belt automatic function (optional)

- The sieve conveyor is controlled by the drive speed, however, if the load on pintle belt 1 is too high, it is additionally controlled by the load
- Minimum and maximum speeds of sieve conveyor are preset
- Ratio between sieve conveyor speed and travel speed is adjustable

Automatic overload and turbo clean

- If a blockage occurs the upstream cleaning units are automatically shut off
- This prevents overrunning or damage due to overloading the harvester
- Turbo Clean program can be activated in the menu

Steering and depth guide

- Stepless depth adjustment of pickup
- Automatic ridge pressure regulation
- Automatic ridge centring

ROPA video switch (optional)

- Automatic activation of the sieving channel, pintle belt, picking conveyor, bunker articulation and rear view camera



Assistance systems and ISOBUS functions

ROPA



Operating units on the sorting platform - all functions



Quick and easy adjustments

Height and inclination of the separating units can be easily adjusted steplessly, hydraulically and electronically at the press of a button

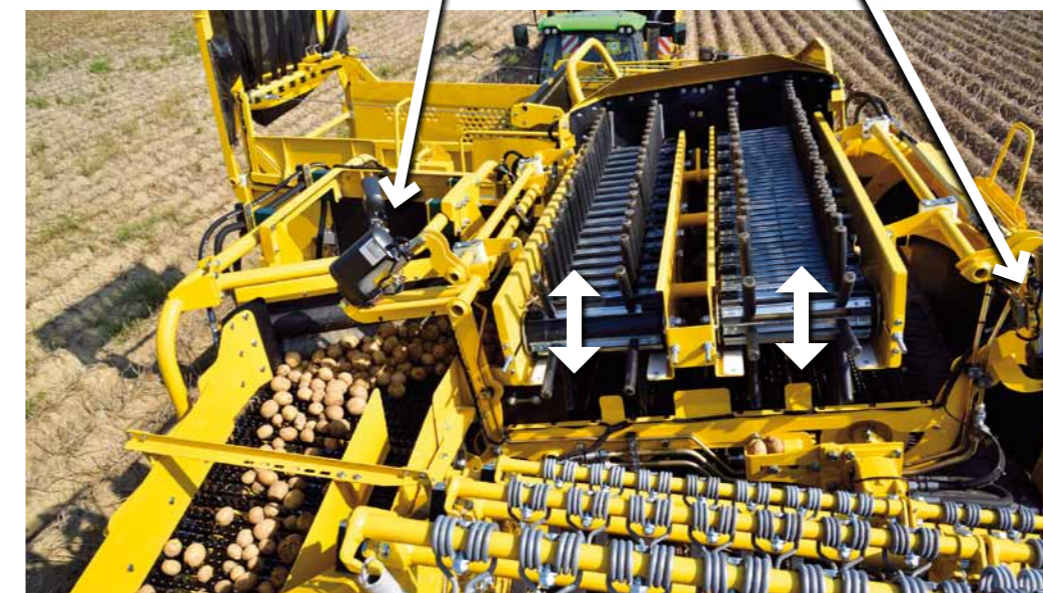

Unique chassis design with telescoping axle and high-volume radial tyres

- Standard high-volume radial tyres 850/50 R30.5, sufficient load capacity with less than 2 bar tyre pressure
- Telescopic axle for increased stability
- Transport width of 3 m on the road
- Outside width of 3.5 m during harvesting
- Lifting through lanes possible
- Optional hydraulically driven axle
- High steering angle, 21 degrees both sides
- Manual/automatic tilt compensation



*except Keiler 2 Classic and Keiler 2 L



Lifting on tracks with retracted telescopic axle - does not run over the potato ridge

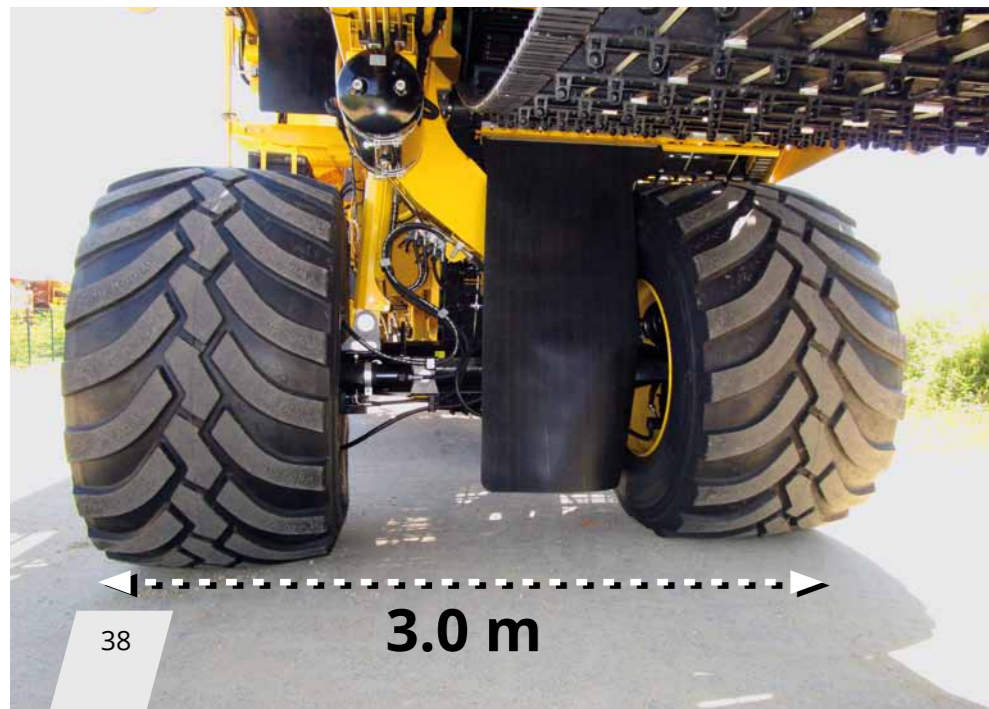

Standard hydraulic slope compensation - optimised cleaning and greater comfort for pickers





Drive wheel

Comfortable and powerful for extreme harvesting conditions

Movement and manoeuvring made easy! The ROPA Keiler 2 can be equipped with a drive wheel for increased traction and soil protection also under extremely difficult harvesting conditions. Even with this optional equipment with high-volume 850/50 R 30.5 tyres the road transport width is just 3.00 metres.

The integrated freewheel of the axle enables a speed of up to 40 km/h when driving on the road. A maximum torque up to 14,500 Nm can be achieved at the wheel for a thrust of 2 tons. Coupling and uncoupling while driving is possible at any time. The maximum speed with a coupled drive wheel is up to 14 km/h.

The new and practical automatic operation using tractors with ISOBUS is a convenient and elegant solution. The drive wheel is automatically actuated in the applicable direction of travel during start-up and controlled synchronously, then switched off again when stopped. A significant advantage, because it is not necessary to switch, stop or switch the drive wheel to reverse separately while moving or starting.

The maximum power consumption in boost operation is 65 kW.

Despite the large-volume 850/50 R30.5 tyres, the steering angle is identical to the original axle and amounts to +/- 21 degrees.



www.ropa-maschinenbau.de

Easy maintenance and accessible design

- Logical electrical design, with all leads labelled throughout the complete cable length
- Integrated diagnostic system
- Bearings, bolts and components conform to DIN standard
- High-quality hydraulic lines

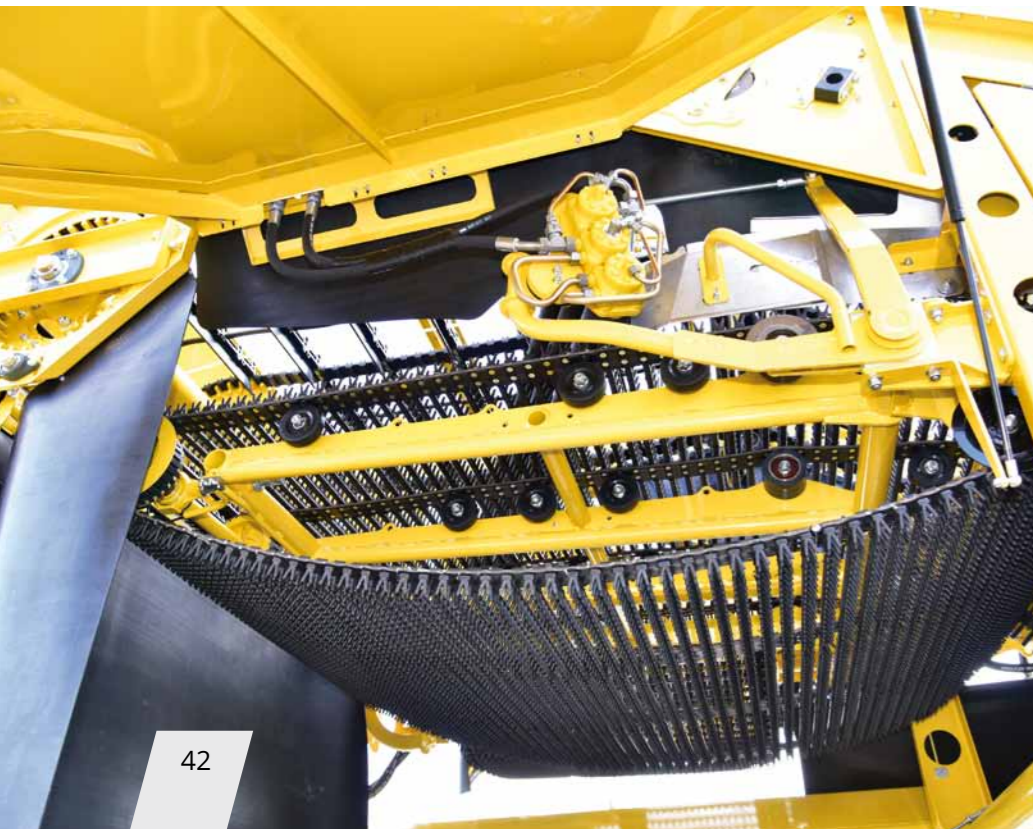



ROPA potato crusher

The ROPA potato crusher is the new sustainable, herbicide-free and resource-saving method for reducing regrowth of potatoes in the successor crop. The potato crusher squeezes and crushes the tubers

sorted out from the discharge chutes and trash track. This promotes rotting and prevents germination of tubers in the following year.



Crushed potatoes have a significantly smaller volume with a much greater surface area, which greatly promotes the decomposition process and prevents germination in the following year. The ROPA potato crusher prevents growth of potato residues, thereby reducing requirements for chemical and mechanical controls.

Shredder blade of steel on one crusher wheel

- **Large potatoes are shredded into small fragments**, until they are caught by the squeezer rollers, crushed and pressed through
- Large tubers are shredded to small pieces, caught and also crushed

Hydraulic drive for rubber wheels

- **The friction effect of the different rotational speeds of the wheels reinforces the shredding effect** during crushing
- The **speed** can be **variably adjusted** by a quantity regulator

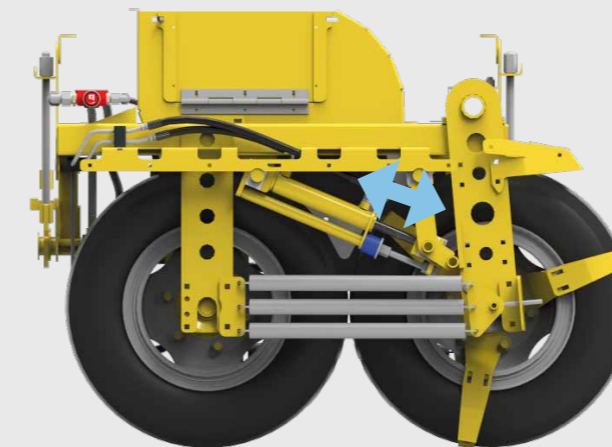
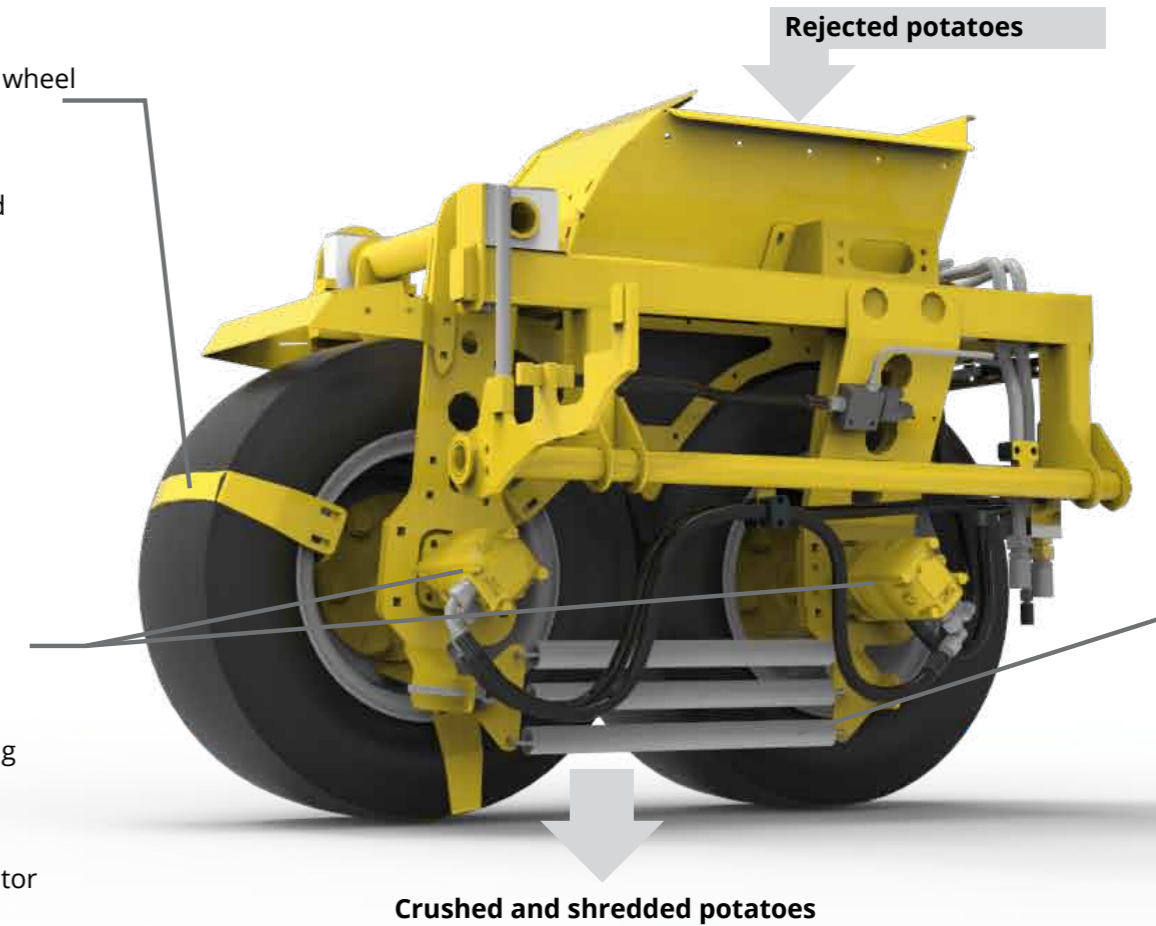

Hydraulic spreading up to 300 mm for free passage

- Lifting without crushing function possible
- Opens to extremely large foreign objects

Very quiet operation

- Squeezer rollers not in direct contact
- The distance between the squeezer rollers can be adjusted by a spindle

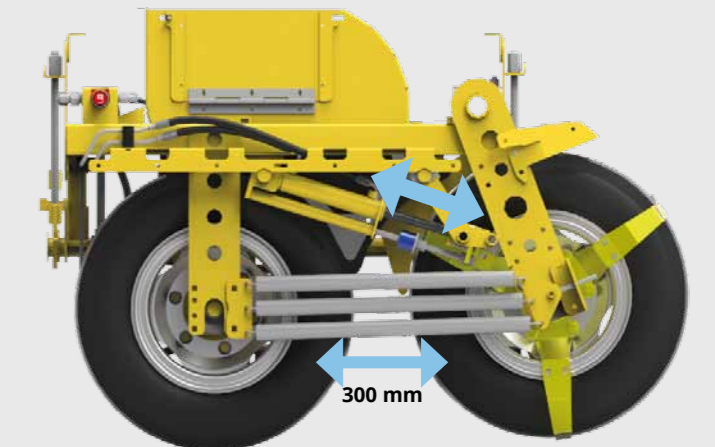

Optional equipment for even more functions



Sunshade canopy, height-adjustable (optional, can be extended with side panels)



Cup holder



Drawbar buffer



Collection box



Combined finger comb and brush comb



Additional cameras for sieve conveyor, leaf chain, pintle belt, picking table, bunker and reversing



Side panels, foldable



Additional height-adjustable working platform



Sieve conveyor tensioner with a separate, retractable cleaning roller





Keiler 2 Classic, Rhineland



Potato field day in Greilsberg, Bavaria



Keiler 2 Silver Edition, North Rhine Westphalia



Keiler 2 with double bunker, Lower Saxony



Keiler 2, North Rhine Westphalia



Keiler 2 L swath pickup, France



Keiler 2, Lower Saxony



Keiler 2 WD, Chile



Keiler 2 L, France



Keiler 2 L, Lower Saxony



Keiler 2 Classic, North Rhine Westphalia



Keiler 2 L WD, Netherlands



Keiler 2 Silver Edition, Lower Saxony



Keiler 2, Bavaria

Technical Data of ROPA Keiler 2:

Length: 11,800 mm
Width: 3,000 mm (Classic 3,300 mm)
Height: 3,990 mm

Coupling:
Ball joint coupling with 80 mm diameter (country-specific achievable).
The length of the drawbar is 2,565 mm.

Tyres:
Two high-volume 850/50 R30.5 radial tyres
(Classic 650/65 R30.5, optional 850/50 R30.5)

Telescopic axle:
The stability of the potato harvester is maintained with a telescopic axle, so that the machine's outer track does not exceed 3,000 mm for transportation and lifting through. For lifting the axle can be widened up to 3,500 mm.

Drive:
The drive is 100% hydraulic. All sieve conveyors and cleaning units can be adjusted steplessly and independently of the PTO rotational speed. The driving speed or harvester's rotational speed remain constant as long as the tractor PTO shaft provides min. 650 rpm.

Pickup:
The pickup unit is equipped with a ROPA quick-change system. The row width can be selected from 750 mm up to 900 mm. The two or four disc coulters (depending on options) are steplessly adjustable to the distance between them. The ridge pickup operates with two ridge rollers, which can be differently configured. Two haulm intake rollers ensure smooth leaf transport. The outer disc coulters in the right direction of travel can be optionally hydraulically driven, an additional disc coulters is optionally available.

Ridge guide:
As standard the machine is provided with a ridge centring function. The depth control is hydraulically operated. Automatic ridge pressure relief or a hydraulic ridge pressure control is also available.

Sieving channel:
Sieve conveyor 1 width: 1,600 mm
Sieve conveyor 2 width: 1,488 mm
As standard, the sieving channel 1 is lined with V2A stainless steel sheets and the hydraulically driven shaker is steplessly adjustable in speed.

Leaf separation:
The leaf separation consists of an electrically adjustable 1,600 mm wide leaf chain and rubberized leaf-separators, situated one after another in 7 rows.
Trash separation:
Pintle belt 1 separating unit:
1,450 mm wide studded rubber belt and triple deflector roller (Classic 1,450 mm)

Pintle belt 2 separating unit:
1,160 mm wide studded rubber belt and twin deflector roller (Classic 1,300 mm triple deflector roller/optional UFK with 4 finger rows)

Pintle belt 3 separating unit:
700 mm wide studded rubber belt and twin deflector roller

Pintle belt 4 separating unit:
1,300 mm wide studded rubber belt and finger comb (UFK) with four rows of fingers. Speed, height and angle are steplessly adjustable from the tractor seat.

Trash track:
350 mm wide including switching flap for trash return
(Classic optionally with trash track, 300 mm wide)

Picking table:
Width: 1,100 mm (Classic 1,000 mm)
Length: 1,900 mm (Classic 5,050 mm)
The picking table is designed for 5 persons (Classic up to 8 persons). Generously dimensioned chutes guarantee a blockage-free removal of trash. Two height-adjustable platforms can be adjusted for different body sizes. Foldaway ladders offer an ergonomic and save ascent and descent.

Operation at harvester:
All functions of the potato harvester can be controlled from the sorting platform with the control unit, including a warning device. Furthermore the speed of the sorting web can be adjusted steplessly by a separate rotary switch.

Bunker:
The pad-roll floor bunker can hold approx. 7.5 t, and approx. 8 t with the Keiler Classic XL. The width of the bunker is 2,235 mm and the maximum truck loading height is 4,200 mm. The two-stage drive is steplessly adjustable. The automatic filling function ensures optimal bunker filling. The bunker can be supplied by an articulation unit, so the fall height of the trailer can be reduced for gentle trailer filling. A hydraulically foldable tray filler in different outflow sizes is optionally available.

Control unit:
The standard control unit uses an ISOBUS touch terminal.

Equipment with added value – standard with us:

- Fully hydraulic drive of the complete harvester
- Automatic ridge centring
- Pickup with quick-change function
- Hydraulic ridge pressure relief steplessly adjustable from the tractor
- Hydraulic lifting depth adjustment combined with hydraulic ridge pressure control
- Sieve conveyors and leaf conveyor are steplessly adjustable from the tractor
- Hydraulically driven shaker with stepless speed adjustment
- Sieving channel 1 with V2A stainless steel sheets
- Tilt adjustment for pintle belt 1 and 2, hydraulic, incl. automatic operation
- Electric height adjustment of the three deflector roller units
- Rotating finger comb (UFK) with 4 rows, each 2 rows driven separately, adjustable speed (Classic optional)
- UFK electric height adjustment (Classic optional)
- Trash conveyor driven and steplessly adjustable separately from the picking conveyor (Classic optional)
- Trash return with switching flap (Classic optional)
- Automatic fall height adjustment and bunker feed with bunker filling carriage
- 7.5 t bunker with pad-roll floor, 8 t XL bunker at Classic
- High-volume standard 850/50 R 30.5 tyres, air brake (Classic optional)
- ISOBUS control unit for easy adjustment of functions from the tractor
- ROPA ISOBUS touch terminal
- K80 ball-head hitch
- Hydraulic support stand
- Telescopic axle, 3 m for road travel and 3.5 m in the field
- Hydraulic tilt compensation for axle, automatically controlled
- Wide-angle universal joint, PTO speed 1,000 rpm
- Automatic overload and turbo clean program for sieve conveyors, leaf chains and pintle belts
- Programming buttons for saving 6 harvesting programs

Some further equipment options:

■ Chassis

- Drive wheel for improved traction automatically actuated in the applicable travel direction

■ Pickup / sieving channel

- Ridge pickup with disc coulters and ridge roller (90 cm)

- Ridge roller: half model, deep model, plastic model

- Two-blade share wide for ridge distance 90 cm

- Three-blade share

- Centre share if the middle disc coulters is not used

- Hydraulics ready for hydraulic disc coulters/swath pickup with lifter shaft and cover belt

- Hydraulically driven disc coulters left and right

- Disc coulters right also mechanical

- Swath pickup with lifter shaft, hydraulic cover belt and depth guide wheels

- Share pickup for special crops (e.g. red beet) with depth guide wheels

- Sieve conveyor 1 cleaning roller

- Rubber paddle roller on drive shaft

- Clod breaker for sieve conveyor 1 and 2

■ Separation

- Tilt adjustment for pintle belt 4, hydraulic

- Pintle belt pitch 40 mm, 36 mm

- Pintle belt with H-profile on round rod instead of V-profile

- Deflector roller package; bottom roller with spiral design (e.g. for carrots)

■ Picking table

- Collection box with discharge conveyor, hydraulically driven

■ Potato crusher

- Hydraulically driven rubber wheels with shredder blade

■ Bunker

- Bunker articulation can be hydraulically lowered

- Tray filler funnel width 900 mm, hydraulically folding

- Tray filler funnel width 1,900 mm, hydraulically folding

- Overloading bunker 5.5 t (Classic 6 t)

- Double bunker at Classic (proportioning 3:1)

- Bunker walls V2A stainless steel (standard bunker)

■ Comfort

- Automatic sieve conveyor controlled by driving speed including automatic pintle belt control

- TASK controller for crop management with ROPA terminal

- ISOBUS retrofit kit for tractor without preparation

- ISOBUS control element with freely assignable AUX function in addition to the right control element

- ROPA video switch between camera system 1 and 2

- 12-inch ROPA touch terminal

■ Lighting

- LED working lights on sieving channel, pintle belt 1 to 2, picking conveyor and bunker discharge

- 1 rotating beacon

- Canopy lights

ROPA



■ Camera and video system

- Video system consisting of one 7-inch TFT monitor with wiring kit for 4 additional camera connections

- Additional video system consisting of one 7-inch TFT monitor with wiring kit for 4 optional camera connections

- Camera position sieving channel 1 to 2

- Camera position pintle belt 1 to 2

- Camera position wheel in direction of travel right

- Camera position picking conveyor

- Camera position dirt discharge conveyor

- Camera position bunker head

- Rear view camera

■ Protection from sun and weather

- Canopy I - sunshade for picking table without side panels, with mounting frame

- Canopy II - weather protection for picking table with side panels, with mounting frame



Copyright 11/20 ROPA-Marketing · P900209GB RK2

ROPA Fahrzeug- und Maschinenbau GmbH
Sittelsdorf 24 · DE-84097 Herrngiersdorf
Tel. +49 (0) 8785/96010

 facebook.com/ROPAmaschinenbau
ropa-maschinenbau.de